





208I/55 5,5 t



-  Sollevatore elettroidraulico a due colonne
-  Electro-hydraulic 2 post lift
-  Elektrohydraulische 2-Säulen-Hebebühne
-  Pont élévateur électrohydraulique à 2 colonnes
-  Elevador electro-hidráulico



Inserimento e sgancio automatico del blocca bracci





Automatic engagement\disengagement of the arm locking device.

Automatisches Ein- und Ausrasten der Armarretiervorrichtung.

Enclenchement et déclenchement automatique du dispositif de blocage des bras.

Introducción y desenganche automático del bloqueo brazos



-  Sollevatore simmetrico senza base, permette la massima comodità nella zona di lavoro • Due cilindri di sollevamento che non richiedono alcuna manutenzione. Le funi non portanti garantiscono la perfetta sincronizzazione dei carrelli indipendentemente dalla ripartizione del carico • Modello equipaggiato con 4 bracci lunghi a tre stadi: ideali per il sollevamento di furgoni e furgonati a passo lungo, consentono allo stesso tempo capacità ottimale anche per le autovetture • Valvola di controllo della velocità di discesa • Sicurezza idraulica in caso di sovraccarico • Sicurezza idraulica in caso di rottura tubi • Comandi uomo presente 24V • Comando di sicurezza ultimo tratto discesa • Segnale acustico ultimo tratto discesa.
-  Baseless lift with symmetric arms for easy work access • 2 lifting rams that require no maintenance • non supporting cables that grant constant synchronization no matter what distribution load is present • designed with 4 extended three-stage telescopic arms ideal for vans, long wheel-based vehicles whilst adaptable for use with standard vehicles • overload safety valve • safety device in case of steel cable damage • 24V dead man control • controlled descent speed by means of hydraulic valve • buzzer signal on last portion of descent phase
-  Die grundrahmenfreie, symmetrische Hebebühne gewährleistet eine bedienerfreundliche Handhabung im Arbeitsbereich • Wartungsfreie Hubzylinder • Die Gleichlauf-Stahlseile gewährleisten den einwandfreien Gleichlauf der Hubschlitten, unabhängig von der Lastverteilung • Dieses Modell ist ausgerüstet mit 4 langen, dreifach teleskopischen Armen. Daher ideal für das Heben von Lieferwagen und Kastenwagen mit langem Radstand und gleichermassen von PKW • Ein Überdruckventil und eine Rohrbruchsicherung runden die Sicherheitsausstattung der Hebebühne ab • 24V-Totmannsteuerung • Fusschutz-Funktion im letzten Abschnitt der Senkfahrt • Akustisches Signal im letzten Abschnitt der Senkfahrt.
-  Elévateur symétrique sans base pour le meilleur confort dans la zone de travail • Les deux vérins de levage ne nécessitent d'aucun entretien. Les câbles en acier non portants assurent la parfaite synchronisation des chariots quelque que soit la distribution du poids • Ce modèle est équipé de 4 bras longs télescopique en trois parties: l'idéal pour le levage de fourgons et véhicules à long empattement, tout en garantissant une capacité de chargement optimale même pour les voitures • soupape de limitation vitesse de descente • soupape de surcharge • Sécurité hydraulique en cas de rupture de tuyauterie • Commandes de type 'homme mort' à 24 V • Commande de sécurité dans la dernière partie de la descente • Signal sonore dans la dernière partie de la descente.
-  El elevador simétrico sin base, permite la máxima comodidad en la zona de trabajo • Dos cilindros de elevación que no requieren ningún mantenimiento, Los cables no portantes garantizan la perfecta sincronización de los carros independientemente de la repartición de la carga • Modelo equipado con 4 brazos largos de tres estadios: ideales para la elevación de camionetas y furgones de paso largo, permiten al mismo tiempo capacidad óptima también para los automóviles • Válvula de control de la velocidad de descenso..



Comando a uomo presente, 24V
 Dead man controls, 24V
 24V - Totman-Schaltung
 Commande "homme mort", 24V
 Mandos de hombre presente, 24V

Sicurezza meccanica sempre attiva e disinserimento tramite magnete a garanzia della massima sicurezza in fase di stazionamento

Mechanical support device with automatic activation and deactivation by means of electromagnetic valve insuring maximum safety during locking procedures

Mechanische Fallsicherung, die automatisch ein- und austrastet, gewährleistet die normkonforme Sicherheit beim Absetzen in die mechanische Fallsicherung

Dispositif d'appui mécanique à insertion automatique et désinsertion électro-magnétique pour la mise en sécurité

Dispositivo de apoyo mecánico de activación automática y desactivación electromagnética como garantía de la máxima seguridad en fase de estacionamiento

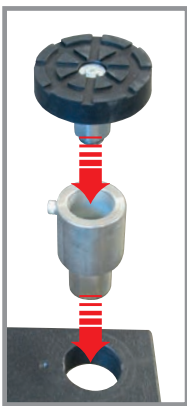

Bracci predisposti per l'alloggiamento rapido di prolunghhe

Arms suitable for quick drop-in extensions

Aufnahmen mit Schnellstecksystem erleichtern den Einsatz von Verlängerungen.

Bras prévus pour le montage rapide de rallonges

Brazos predisuestos para el alojamiento rápido de suplementos.



Opzioni



Optionals



Sonderzubehör



Options



Opcionales

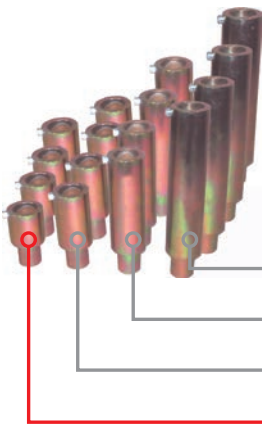

Estensioni per tamponi (kit 4 pz)
 Lifting pad extensions (4 pcs set)
 Hubspindelverlängerungen (Satz 4 Stk)
 Rallonges pour tampons (jeu de 4 pcs)
 Extensiones para tacos (kit 4 un.)

250 mm (L955)

170 mm (L954)

100 mm (L953)

60 mm (L956 standard included)

Esecuzione con motore monofase

Single-phase motor

Moteur monophasé

Ausführung mit Einphasenmotor

Motor monofásico



208I/55 5,5 t

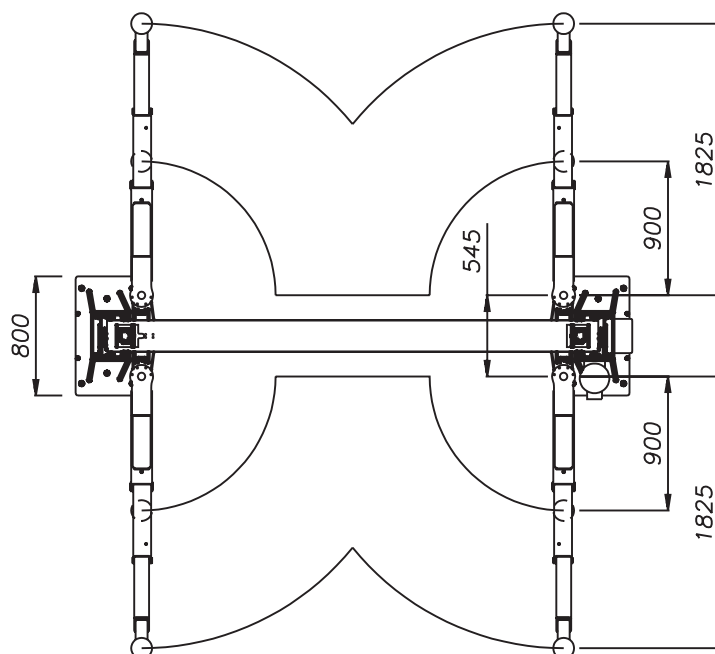
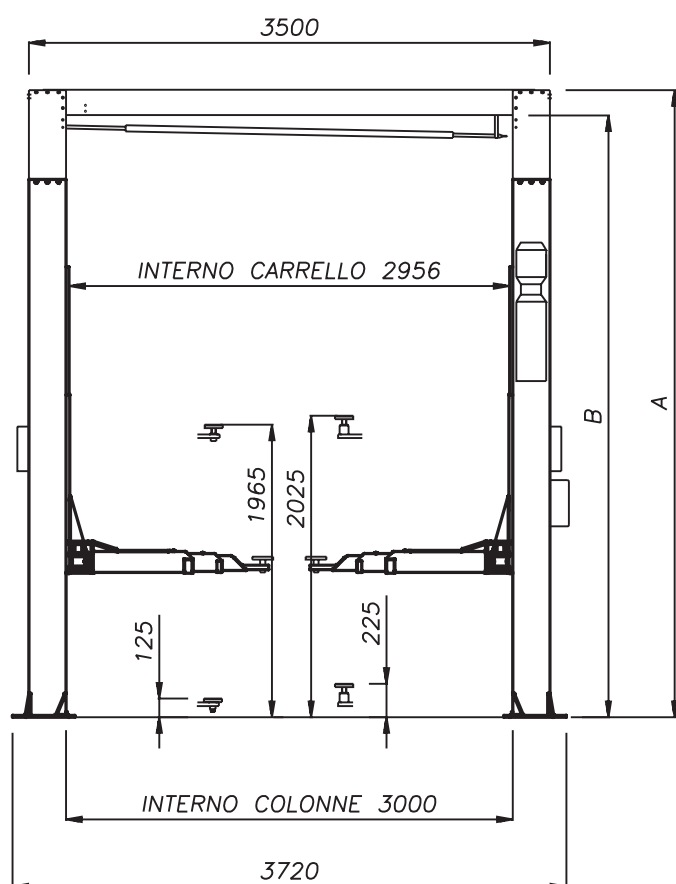

	Versione / Version / Version / Version	
	208I/55	208I/55.4
A	4200 (3600+600)	5100 (3600+1500)
B	4030	4930



Dati tecnici	Technical data	Technische Eigenschaften	Caractéristiques techniques	Datos técnicos	
Portata	Capacity	Tragfähigkeit	Capacité	Capacidad	5.500 kg
Peso	Weight	Gewicht	Poids	Peso	1010-1080 kg
Salita/Discesa	Lifting/lowering	Hub/Senkzeit	Levage/descente	Subida/bajada	35 s
Altezza di sollevamento	Lifting height	Hubhöher	Hauteur de levage	Altura de elevación	1965 mm
Motore	Motor	Motorleistung	Puissance moteur	Motor	3 kW - 3 ph 230-400V/50 Hz-