











# 263/35HS | 3,5 t



-  Ponte elettroidraulico a forbice di media altezza per gommisti e carrozzieri.
-  **Electro-hydraulic, mid-raise scissor lift for tyre and car body shops.**
-  Elektrohydraulischer Mittelhub-Scherenheber für Reifenservice und Karosserieshops.
-  Pont électro-hydraulique basse levée pour spécialistes de pneus et carrosseries.
-  Elevador electro-hidráulico de tijera, de mediana altura, para carrocerías y talleres de neumáticos.



-  Rampette di salita e discesa di facile movimentazione • Parallelismo idraulico e sincronismo delle pedane • Sicurezza idraulica in caso di sovraccarico • Sicurezza idraulica in caso di rottura dei tubi • Valvola controllo velocità di discesa • Comandi uomo presente, 24V • Serie 4 tamponi in gomma • Comando di sicurezza ultimo tratto di discesa • Segnale acustico ultimo tratto di discesa.
-  **Easy to handle drive-on & drive-off ramps • hydraulically controlled synchronized platforms • overload safety valve • safety valve in case of pressure loss • descent speed control valve • 24V dead man control • set of 4 rubber pads • safety control device & "buzzer" signal on last portion of descent phase.**
-  Einfachste Bedienung der Auf- und Abfahrrampen • Hydraulische Gleichlaufregulierung der Fahrschienen • Überlastsicherung mittels Überdruckventil • Rohrbruchsicherung • Sinkgeschwindigkeits-Regelventil • Totmann-Steuerung (24 V-Niederspannung) • 4 Fahrzeugaufnahme-Gummiblöcke • Sicherheitssteuerung im letzten Abschnitt der Senkbewegung • Akustisches Signal im letzten Abschnitt der Senkbewegung.
-  Rampes de montée et descente • Parallélisme hydraulique et synchronisme des plateformes de levage • Sécurité hydraulique en cas de surcharge • Sécurité hydraulique en cas de rupture de tuyauterie • Soupape de contrôle de vitesse de descente • Commandes de type "homme mort" à 24V • Jeux de 4 taquets en caoutchouc • Commande de sécurité (chasse-pieds) dans la dernière partie de la descente • Signal sonore dans la dernière partie de la descente.
-  Rampas de elevación/descenso fáciles de desplazar • Paralelismo hidráulico y sincronismo de las plataformas • Seguridad hidráulica contra la sobrecarga • Seguridad hidráulica contra la rotura de tubos • Válvula de control de velocidad • Mandos de hombre presente, 24V • Serie de 4 tacos de goma • Mando de seguridad último tramo de descenso • Señal acústica último tramo de descenso.

# 263/35HS | 3,5 t

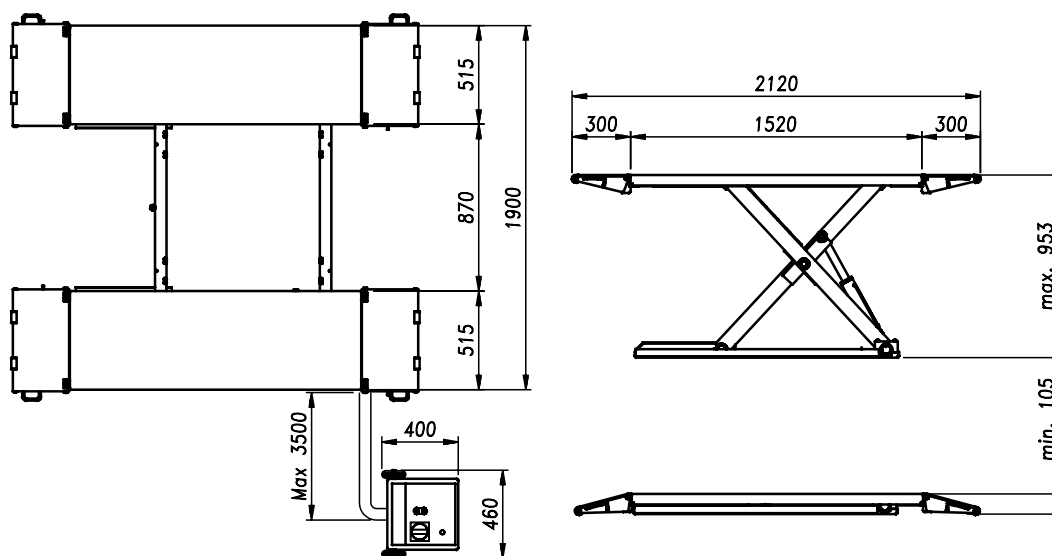

## Dati tecnici

## Technical data

## Technische Eigenschaften

## Caractéristiques techniques

## Datos técnicos

Portata	Capacity	Tragfähigkeit	Capacité	Capacidad	3.500 kg
Peso	Weight	Gewicht	Poids	Peso	600 kg
Salita/Discesa	Lifting/lowering	Hub/Senkzeit	Levage/déscente	Subida/Baja	18/18 s HS
Altezza di sollevamento	Lifting height	Hubhöhe	Hauteur de levage	Altura de elevación	953 mm
Motore	Motor	Motorleistung	Puissance moteur	Motor	2,2 kW - 400V/50 Hz



Doppio circuito idraulico indipendente.  
Distributore di flusso in centralina.

Double hydraulic circuit system  
with flow distributor.

Zweifaches, getrenntes Hydraulik-Hubsystem.  
Wegeventil an der Hydraulikeinheit im Steuerkasten.

Système hydraulique double et séparé.  
Déviateur hydraulique placé sur la centrale hydraulique dans le pupitre de commande.

Doble circuito hidráulico y cada independiente.  
Distribuidor de flujo situado en la unidad de mando.

ALTEZZA MINIMA: 105 mm  
Facile accesso anche con vetture ribassate

MINIMAL HEIGHT: 105 mm  
Easy to drive-over even with low cars

MINDESTHÖHE: 105 mm  
Einfaches Überfahren auch mit tiefgelegten Fahrzeugen

HAUTEUR MINIMUM: 105 mm  
Accès très facile même avec voitures très basses

ALTURA MÍNIMA: 105 mm  
Acceso facilitado también con vehículos de perfil bajo



## Opzioni

## Optionals

## Sonderzubehör

## Options

## Opcionales



Kit ruote trasporto  
Set of wheels  
Satz Hilfsräder  
Jeu de roues de déplacement  
Kit ruedas transporte



Rampe ausiliarie  
Auxiliary drive on-/drive-off ramps  
Zusatzrampen  
Rampes auxiliaires de monté/déscente  
Rampas auxiliares

Esecuzione Monofase • Single phase version • Einphasige Ausführung • Version monophasée • Motor monofásico

Kit scivoli per incasso • Kit of embedded run-on and run-off skids • Satz Abrollrampen für Bodeneinbau. • Jeu de rampes de roulement pour encastrement • Juego de rampas para empotrar