











263/B HS | 3,0 t



-  Ponte elettroidraulico a forbice di media altezza per gommisti e carrozzieri
-  **Electro-hydraulic, mid-raise scissor lift for tyre and car body shops**
-  Elektrohydraulischer Mittelhub-Scherenheber für Reifenservice und Karosserieshops
-  Pont électro-hydraulique basse levée pour spécialistes de pneus et carrosseries
-  Elevador electro-hidráulico de tijera, de mediana altura, para carrocerías y talleres de neumáticos



-  Rampette di salita e discesa di facile movimentazione • Parallelismo idraulico e sincronismo delle pedane • Sicurezza idraulica in caso di sovraccarico • Sicurezza idraulica in caso di rottura dei tubi • Regolazione automatica della discesa • Comandi uomo presente, 24V • Serie 4 tamponi in gomma • Comando di sicurezza ultimo tratto di discesa • Segnale acustico ultimo tratto di discesa
-  **Easy to handle drive-on and drive-off ramps • Hydraulically synchronized platforms • Overload safety-valve • Safety-valve in case of sudden loss of pressure • Automatic lowering control • "Dead man" controls 24V • Set of 4 rubber pads • Safety control on last descent segment • 'Buzzer' on last portion of descent**
-  Einfachste Bedienung der Auf- und Abfahrrampen • Hydraulische Gleichlaufregulierung der Fahrschienen • Überlastsicherung mittels Überdruckventil • Rohrbruchsicherung • Automatische Senkregulierung • Totmann-Steuerung (24 V-Niederspannung) • 4 Fahrzeugaufnahme-Gummiblöcke • Sicherheitsantrieb auf letztem Abstiegsabschnitt • Akustisches Signal im letzten Teil der Senkbewegung
-  Rampes de montée et descente • Parallélisme hydraulique et synchronisme des plateformes de levage • Sécurité hydraulique en cas de surcharge • Sécurité hydraulique en cas de rupture de tuyauterie • Autorégulation de descente • Commandes de type "homme mort" à 24V • Jeux de 4 taquets en caoutchouc • Commande de sécurité fin descente • Signal sonore sur la dernière partie de descente
-  Rampas de elevación/descenso fáciles de desplazar • Paralelismo hidráulico y sincronismo de las plataformas • Seguridad hidráulica contra la sobrecarga • Seguridad hidráulica contra la rotura de tubos • Regulación automática del descenso • Mandos de hombre presente, 24V • Serie de 4 tacos de goma • Mando de seguridad último tramo de descenso • Señal acústica último tramo de descenso

263/B HS | 3,0 t

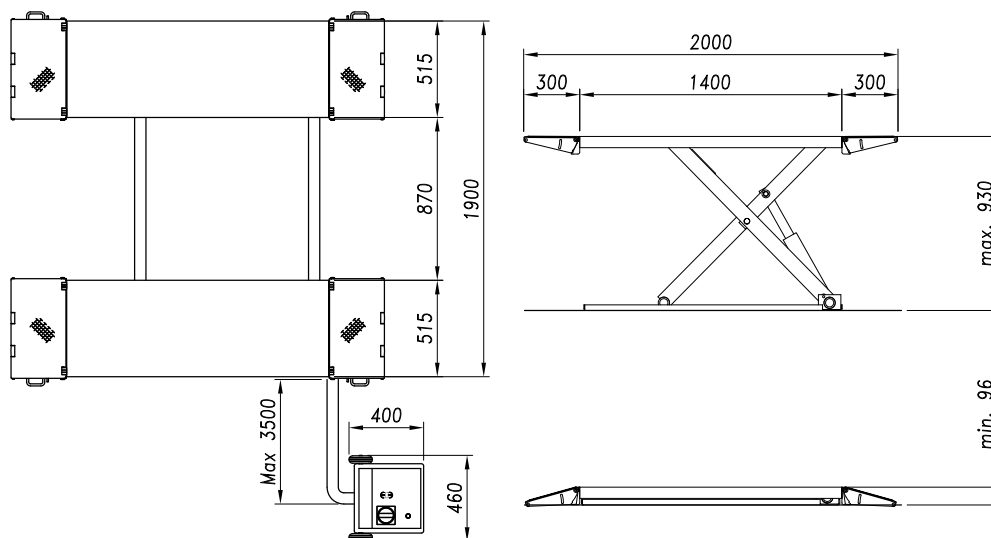

Dati tecnici

Technical data

Technische Eigenschaften

Caractéristiques techniques

Datos técnicos

Portata • Capacity • Tragfähigkeit • Capacité • Capacidad	3.000 kg
Peso • Weight • Gewicht • Poids • Peso	500 kg
Salita/Discesa • Lifting/lowering • Hub/Senkzeit • Levage/descente • Subida/bajada	20/20 s HS
Altezza di sollev. • Lifting height • Hubhöhe • Hauteur de levage • Altura de elevación	930 mm
Lunghezza • Length • Länge • Longueur • Longitud	1.400 / 2.000 mm
Larghezza max. • Overall width • Breite • Largeur • Ancho máx.	1.900 mm
Motore • Motor • Motorleistung • Puissance moteur • Motor	2,2 kw - 400V/50 Hz



Doppio circuito idraulico di sicurezza
Coppia di cilindri volumetrici sotto
ciascuna pedana

Double hydraulic system
Double volumetric cylinder under
each platform

Zweifaches Hydrauliksystem
Doppelzylinder in jeder Schere
Système hydraulique double
Double vérin hydraulique sous chaque
plateforme

Doble circuito hidráulico de seguridad
Pareja de cilindros volumétricos debajo
de cada plataforma

ALTEZZA MINIMA: 95 mm
Facile accesso anche con vetture ribassate

MINIMAL HEIGHT: 95 mm
Easy to drive-over even with low cars

MINDESTHÖHE: 95 mm
Einfaches Überfahren auch mit tiefgelegten Fahrzeugen

HAUTEUR MINIMUM: 95 mm
Accès très facile même avec voitures très basses

ALTURA MÍNIMA: 95 mm
Acceso facilitado también con vehículos de perfil bajo



Opzioni

Optionals

Sonderzubehör

Options

Opcionales



Kit ruote trasporto
Set of wheels
Satz Hilfsräder
Chariot de déplacement
Kit ruedas transporte



Rampe ausiliarie
Auxiliary drive on-/drive-off ramps
Zusatzrampen
Rampes auxiliaires de montée/descente
Rampas auxiliares

Kit scivoli per incasso
Kit of embedded run-on and run-off skids
Satz Abrollrampen für Bodeneinbad
Jeu de rampes de roulement pour encastrement
Juego de rampas para empotrar