











-  Ponte elettroidraulico a forbice di media altezza per gommisti e carrozzieri
-  **Electro-hydraulic, mid-raise scissor lift for tyre and car body shops**
-  Elektrohydraulischer Mittelhub-Scherenheber für Reifenservice und Karosserieshops
-  Pont électro-hydraulique basse levée pour spécialistes de pneus et carrosseries
-  Elevador electro-hidráulico de tijera, de mediana altura, para carrocerías y talleres de neumáticos



-  Rampette di salita e discesa di facile movimentazione • Parallelismo idraulico e sincronismo delle pedane • Sicurezza idraulica in caso di sovraccarico • Sicurezza idraulica in caso di rottura dei tubi • Regolazione automatica della discesa • Comandi uomo presente, 24V • Serie 4 tamponi in gomma • Comando di sicurezza ultimo tratto di discesa • Segnale acustico ultimo tratto di discesa
-  **Easy to handle drive-on and drive-off ramps • Hydraulically synchronized platforms • Overload safety-valve • Safety-valve in case of sudden loss of pressure • Automatic lowering control • "Dead man" controls 24V • Set of 4 rubber pads • Safety control on last descent segment • 'Buzzer' on last portion of descent**
-  Einfachste Bedienung der Auf- und Abfahrrampen • Hydraulische Gleichlaufregulierung der Fahrschienen • Überlastsicherung mittels Überdruckventil • Rohrbruchsicherung • Automatische Senkregulierung • Totmann-Steuerung (24 V-Niederspannung) • 4 Fahrzeugaufnahme-Gummiblöcke • Sicherheitsantrieb auf letztem Abstiegsabschnitt • Akustisches Signal im letzten Teil der Senkbewegung
-  Rampes de montée et descente • Parallélisme hydraulique et synchronisme des plateformes de levage • Sécurité hydraulique en cas de surcharge • Sécurité hydraulique en cas de rupture de tuyauterie • Autorégulation de descente • Commandes de type "homme mort" à 24V • Jeux de 4 taquets en caoutchouc • Commande de sécurité fin descente • Signal sonore sur la dernière partie de descente
-  Rampas de elevación/descenso fáciles de desplazar • Paralelismo hidráulico y sincronismo de las plataformas • Seguridad hidráulica contra la sobrecarga • Seguridad hidráulica contra la rotura de tubos • Regulación automática del descenso • Mandos de hombre presente, 24V • Serie de 4 tacos de goma • Mando de seguridad último tramo de descenso • Señal acústica último tramo de descenso

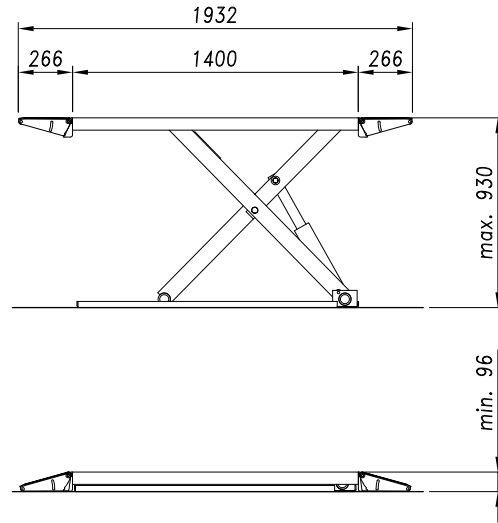
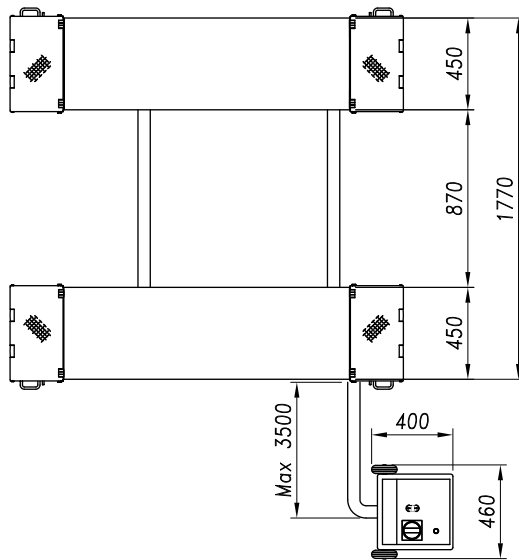

## Dati tecnici

## Technical data

## Technische Eigenschaften

## Caractéristiques techniques

## Datos técnicos

Portata • Capacity • Tragfähigkeit • Capacité • Capacidad	3.000 kg
Peso • Weight • Gewicht • Poids • Peso	500 kg
Salita/Discesa • Lifting/lowering • Hub/Senkzeit • Levage/descente • Subida/bajada	30/35 s
Altezza di sollev. • Lifting height • Hubhöhe • Hauteur de levage • Altura de elevación	930 mm
Lunghezza • Length • Länge • Longueur • Longitud	1.400 / 1.932 mm
Larghezza max. • Overall width • Breite • Largeur • Ancho máx.	1.770 mm
Motore • Motor • Motorleistung • Puissance moteur • Motor	1,1 kw - 400V/50 Hz



Doppio circuito idraulico di sicurezza  
Coppia di cilindri volumetrici sotto  
ciascuna pedana

**Double hydraulic system**  
**Double volumetric cylinder under**  
**each platform**

Zweifaches Hydrauliksystem  
Doppelzylinder in jeder Schere  
Système hydraulique double  
Double vérin hydraulique sous chaque  
plateforme

Doble circuito hidráulico de seguridad  
Pareja de cilindros volumétricos debajo  
de cada plataforma

ALTEZZA MINIMA: 95 mm  
Facile accesso anche con vetture ribassate

**MINIMAL HEIGHT: 95 mm**  
**Easy to drive-over even with low cars**

MINDESTHÖHE: 95 mm  
Einfaches Überfahren auch mit tiefgelegten Fahrzeugen

HAUTEUR MINIMUM: 95 mm  
Accès très facile même avec voitures très basses

ALTURA MÍNIMA: 95 mm  
Acceso facilitado también con vehículos de perfil bajo



## Opzioni

## Optionals

## Sonderzubehör

## Options

## Opcionales



Kit ruote trasporto  
**Set of wheels**  
Satz Hilfsräder  
Chariot de déplacement  
Kit ruedas transporte



Rampe ausiliarie  
**Auxiliary drive on-/drive-off ramps**  
Zusatzrampen  
Rampes auxiliaires de montée/descente  
Rampas auxiliares

Kit scivoli per incasso  
**Kit of embedded run-on and run-off skids**  
Satz Abrollrampen für Bodeneinbad  
Jeu de rampes de roulement pour encastrement  
Juego de rampas para empotrar