











412 12,0 t



-  Sollevatore elettroidraulico a 4 colonne
-  Electro-hydraulic 4 post lift
-  lektrohydraulische 4-Säulenbühne
-  Pont élévateur électro-hydraulique 4 colonnes
-  Elevador electro-hidráulico de 4 columnas



-  Sicurezza in caso di rottura fune • Sicurezza idraulica in caso di sovraccarico • Valvola di controllo velocità discesa • Valvola sicurezza in caso di rottura tubo idraulico • Comandi uomo presente 24V • Comando sgancio elettrico • Insonorizzazione sicurezze • Avvisatore acustico fase finale discesa
-  Safety device in case of cable breakage • Overload safety-valve • Descent control valve • Safety-valve in case of sudden loss of pressure • "Dead man" controls 24V • Automatic release of safety locking devices • Soundproof safety devices • Buzzer on last portion of descent
-  Seilbruchsicherung • Überdrucksicherung • Sinkgeschwindigkeits-Regelventil • Rohrbruch-Sicherheitsventil • Totmann-Schaltung 24V • Elektrische Entriegelung der Sicherheitsrasten • Schalldaempfung Sicherheitshebel
 - Akustisches Signal Endphase Abstieg
-  Sécurité en cas de rupture d'un cable • Sécurité hydraulique en cas de surcharge • Vanne de contrôle descente • Vanne de sécurité en cas de rupture de tuyantene • Commande de type "homme mort" 24V • Déverrouillage à commande électrique • Insonorisation sécurité • Signal sonore sur la dernière partie de la descente
-  Seguridad en caso de rotura cable • Seguridad hidráulica en caso de sobrecarga • Válvula de control velocidad descenso • Válvula de seguridad en caso de rotura del tubo hidráulico • Mandos de "hombre presente", 24V • Mando de desenganche eléctrico • Insonorización seguridades • Aviso acústico fase final de bajada

412 12,0 t

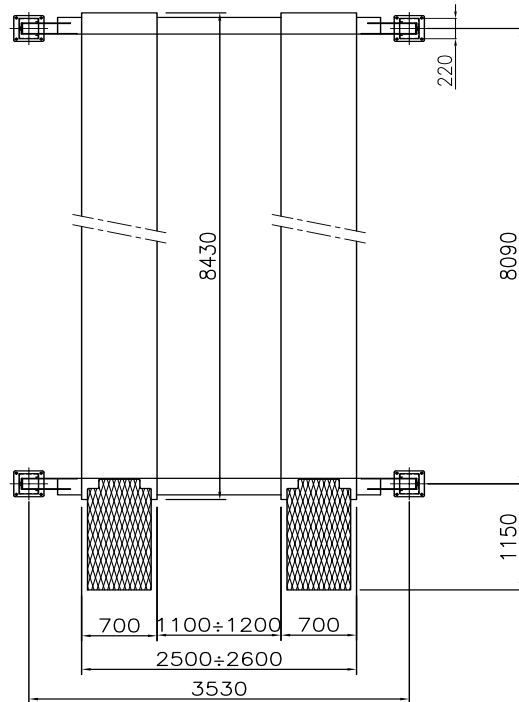
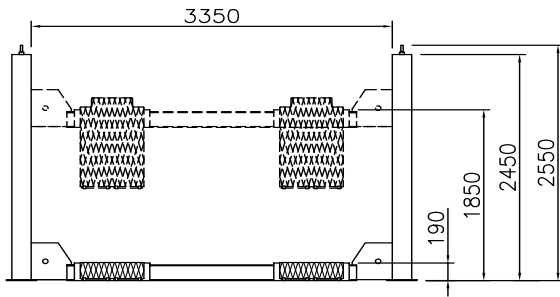

Dati tecnici	Technical data	Technische Eigenschaften	Caractéristiques techniques	Datos técnicos	
Funzionamento: Elettroidraulico	Operation: Electro-hydraulic	Funktionsweise: Elektrohydraulisch	Fonctionnement: Electrohydraulique	Funcionamiento: Electro-hidráulico	
Portata	Capacity	Tragfähigkeit	Capacité	Capacidad	12.000 kg
Peso	Weight	Gewicht	Poids	Peso	3000 kg
Salita/Discesa	Lifting/lowering	Hub/Senkzeit	Levage/descente	Subida/bajada	65 s
Altezza di sollevamento	Lifting height	Hubhöhe	Hauteur de levage	Altura de elevación	1850 mm
Motore	Motor	Motorleistung	Puissance moteur	Motor	3 kW - 3 ph 230 400V/50 Hz



Opzioni	Optionals	Sonderzubehör	Options	Opcionales
---------	-----------	---------------	---------	------------



.6R

Traversa idraulica ausiliaria (vedere scheda specifica)
Hydraulic jacking beam (see relevant data sheet)
 Hydraulischer Radfreiheber (s. eigenes Datenblatt)
 Levage auxiliaire hydraulique (voir fiche technique)
 Elevador hidráulico auxiliar (ver ficha técnica)

Esecuzione con motore monofase
Single-phase motor
 Ausführung mit Einphasenmotor
 Moteur monophasé
 Motor monofásico

Kit illuminazione
Illumination kit
 Beleuchtungsset
 Kit d'éclairage
 Kit de iluminación

Carter protezione centralina
Cover for control unit
 Abdeckung für HydraulikaggregatRa
 Carter protection centrale hydraulique
 Cubierta protectora para la centralita