











450N/5 5,0 t



-  Sollevatore elettroidraulico a 4 colonne
-  Electro-hydraulic 4 post lift
-  lektrohydraulische 4-Säulenbühne
-  Pont élévateur électro-hydraulique 4 colonnes
-  Elevador electro-hidráulico de 4 columnas



-  Sicurezza idraulica contro il sovraccarico • Valvola regolazione discesa • Stop automatico in discesa • Segnale acustico ultimo tratto di discesa • Sicurezza idraulica in caso di rottura tubi idraulici • Comandi uomo presente 24 V • Sgancio automatico delle sicurezze per la discesa
-  Overload safety valve • Descent control valve • Automatic descent stop • "Buzzer" on last portion of descent • Pipe burst safety valve • 24 V low tension dead man controls • Automatic release of safety locking devices
-  Überdruckventil als Überlastsicherung • Senksteuerventil • Automatische Senkstop-Steuerung • Akustisches Signal im letzten Teil der Senkbewegung • Rohrbruch-Sicherheitsventil • 24 V-Totmannschaltung • Automatische Entriegelung der Lastsicherungshebel vor dem Absenken
-  Vanne de surpression contre surcharges • Vanne de réglage descente • Arrêt automatique en descente • Signal sonore sur la dernière partie de descente • Vanne d'arrêt en cas de rupture de la tuyauterie • Commandes de type homme mort à 24 V • Déclenchement automatique des crochets lors de la descente
-  Seguridad hidráulica contra la sobrecarga • Válvula de regulación del descenso • Parada automática en descenso • Señal acústica último tramo de descenso • Seguridad hidráulica en caso de rotura tubos hidráulicos • Mandos de hombre presente, 24V • Desenganche automático de las seguridades para el descenso

450N/5 5,0 t

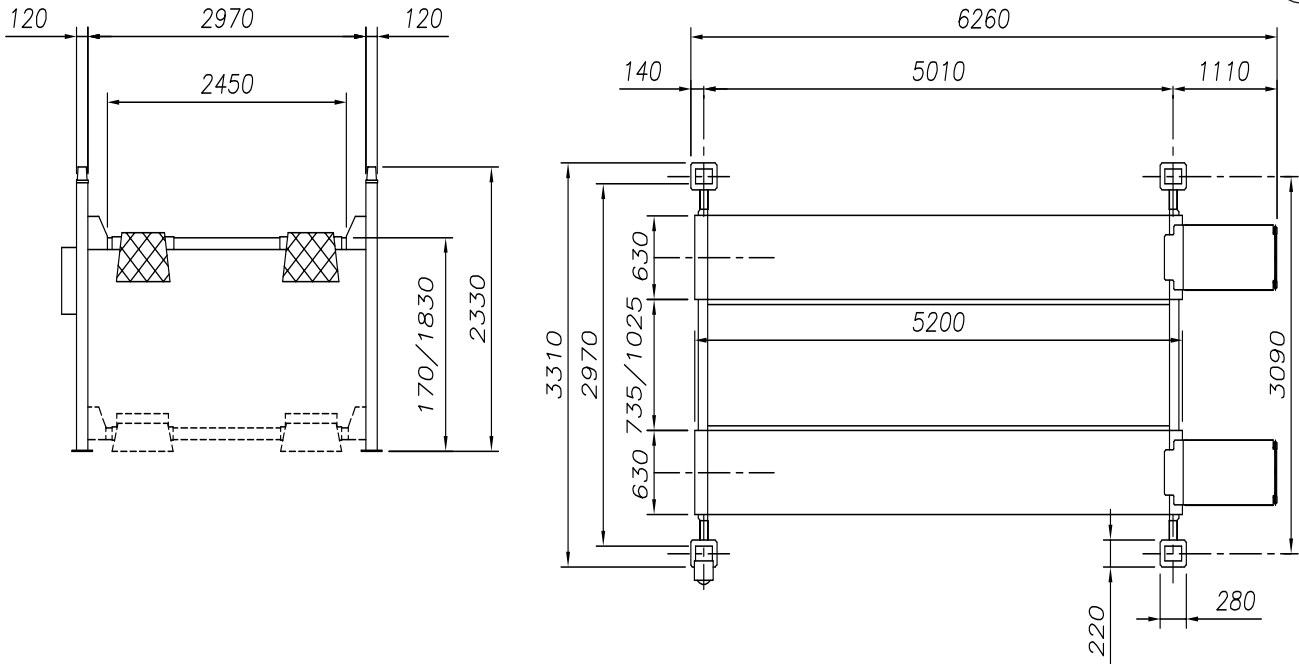

Dati tecnici	Technical data	Technische Eigenschaften	Caractéristiques techniques	Datos técnicos	
Funzionamento: Elettroidraulico	Operation: Electro-hydraulic	Funktionsweise: Elektrohydraulisch	Fonctionnement: Electrohydraulique	Funcionamiento: Electro-hidráulico	
Portata	Capacity	Tragfähigkeit	Capacité	Capacidad	5.000 kg
Peso	Weight	Gewicht	Poids	Peso	1440 kg
Salita/Discesa	Lifting/lowering	Hub/Senkzeit	Levage/descente	Subida/bajada	50 / 45 s
Altezza di sollevamento	Lifting height	Hubhöhe	Hauteur de levage	Altura de elevación	1830 mm
Motore	Motor	Motorleistung	Puissance moteur	Motor	2,2 kW - 3 ph 230 400V/50 Hz



Opzioni	Optionals	Sonderzubehör	Options	Opcionales
---------	-----------	---------------	---------	------------



4

Traversa idraulica ausiliaria (vedere scheda specifica)
Hydraulic jacking beam (see relevant data sheet)
 Hydraulischer Radfreiheber (s. eigenes Datenblatt)
 Levage auxiliaire hydraulique (voir fiche technique)
 Elevador hidráulico auxiliar (ver ficha técnica)

Esecuzione con motore monofase
Single-phase motor
 Ausführung mit Einphasenmotor
 Moteur monophasé
 Motor monofásico

Kit illuminazione
Illumination kit
 Beleuchtungsset
 Kit d'éclairage
 Kit de iluminación

Carter protezione centralina
Cover for control unit
 Abdeckung für HydraulikaggregatRa
 Carter protection centrale hydraulique
 Cubierta protectora para la centralita