











# 460 6,0 t









-  Sollevatore elettroidraulico a 4 colonne
-  Electro-hydraulic 4 post lift
-  lektrohydraulische 4-Säulenbühne
-  Pont élévateur électro-hydraulique 4 colonnes
-  Elevador electro-hidráulico de 4 columnas

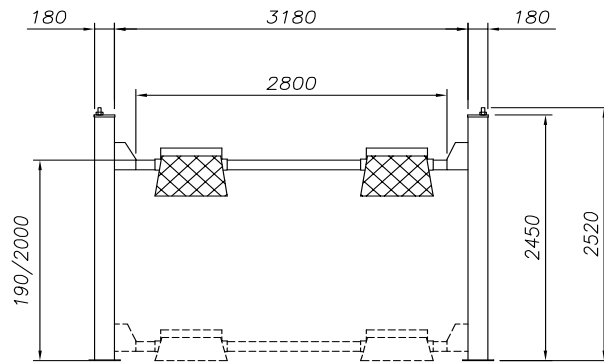
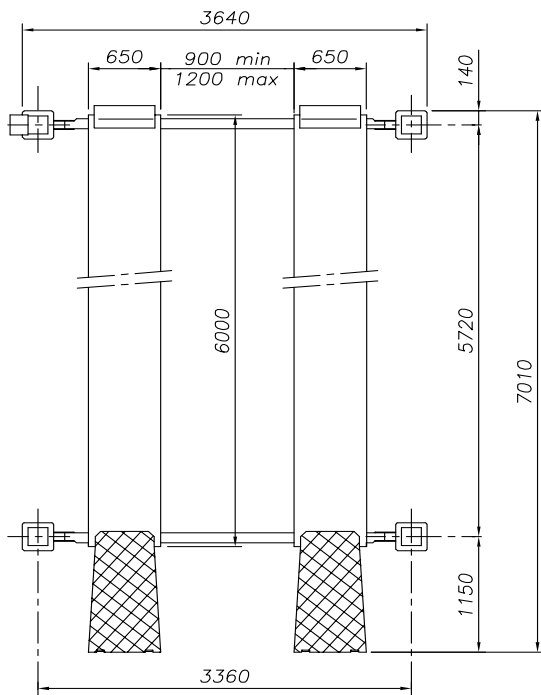





-  Sicurezza in caso di rottura fune • Sicurezza idraulica in caso di sovraccarico • Valvola di controllo velocità discesa • Valvola sicurezza in caso di rottura tubo idraulico • Comandi uomo presente 24V • Comando sgancio elettrico • Comando automatico di discesa • Insonorizzazione sicurezze • Avvisatore acustico fase finale discesa
-  Safety device in case of cable breakage • Overload safety-valve • Descent control valve • Pipe burst safety valve • 24V, low tension dead man controls • Electrical controlled fall safety • Automatic release of safety locking devices • Automatic descent control • Soundproof safety devices • Buzzer on last portion of descent
-  Seilbruchsicherung • Überdrucksicherung • Sinkgeschwindigkeits-Regelventil • Rohrbruch-Sicherheitsventil • Totmann-Schaltung 24V • Elektrische Entriegelung der Sicherheitsrasten • Autom. Sicherheitsstop • Schalldaempfung Sicherheit-shebel • Akustisches Signal Endphase Abstieg
-  Sécurité en cas de rupture d'un cable • Sécurité hydraulique en cas de surcharge • Vanne de contrôle descente • Vanne de sécurité en cas de rupture de tuyauterie • Commande de type "homme mort" 24V • Déverrouillage à commande électrique • Commande automatique de descente • Insonorisation sécurité • Signal sonore sur la dernière partie de la descente
-  Seguridad en caso de rotura cable • Seguridad hidráulica en caso de sobrecarga • Válvula de control velocidad descenso • Válvula de seguridad en caso de rotura del tubo hidráulico • Mandos de "hombre presente", 24V • Mando de desenganche eléctrico • Mando automático de descenso • Insonorización seguridades • Aviso acústico fase final de bajada

# 460 6,0 t



 Dati tecnici	 Technical data	 Technische Eigenschaften	 Caractéristiques techniques	 Datos técnicos	
Funzionamento: Elettroidraulico	Operation: Electro-hydraulic	Funktionsweise: Elektrohydraulisch	Fonctionnement: Electrohydraulique	Funcionamiento: Electro-hidráulico	
Portata	Capacity	Tragfähigkeit	Capacité	Capacidad	6.000 kg
Peso	Weight	Gewicht	Poids	Peso	1730 kg
Salita/Discesa	Lifting/lowering	Hub/Senkzeit	Levage/descente	Subida/bajada	75 / 50 s
Altezza di sollevamento	Lifting height	Hubhöhe	Hauteur de levage	Altura de elevación	2000 mm
Motore	Motor	Motorleistung	Puissance moteur	Motor	3 kW - 3 ph 230 400V/50 Hz

 Opzioni	 Optionals	 Sonderzubehör	 Options	 Opcionales
--	---	---	---	--



.10

Traversa idraulica ausiliaria (vedere scheda specifica)  
**Hydraulic jacking beam** (see relevant data sheet)  
 Hydraulischer Radfreiheber (s. eigenes Datenblatt)  
 Levage auxiliaire hydraulique (voir fiche technique)  
 Elevador hidráulico auxiliar (ver ficha técnica)

Esecuzione con motore monofase  
**Single-phase motor**  
 Ausführung mit Einphasenmotor  
 Moteur monophasé  
 Motor monofásico

Kit illuminazione  
**Illumination kit**  
 Beleuchtungsset  
 Kit d'éclairage  
 Kit de iluminación

Carter protezione centralina  
**Cover for control unit**  
 Abdeckung für HydraulikaggregatRa  
 Carter protection centrale hydraulique  
 Cubierta protectora para la centralita