











J2P

-  Cric pneumatico portatile a 2 stadi
-  **Pneumatic 2-stage jack**
-  Pneumatischer Wagenheber mit 2 Stufen
-  Cric pneumatique à 2 étages
-  Gato neumático portátil de 2 etapas







J3P

-  Cric pneumatico portatile a 3 stadi
-  **Pneumatic 3-stage jack**
-  Pneumatischer Wagenheber mit 3 Stufen
-  Cric pneumatique à 3 étages
-  Gato neumático portátil de 3 etapas







J2C

-  Cric pneumatico portatile a 2 stadi con carrello
-  **Pneumatic 2-stage jack with trolley**
-  Pneumatischer Wagenheber mit 2 Stufen, mit Wagen
-  Cric pneumatique à 2 étages à chariot
-  Gato neumático portátil de 2 etapas con carrito



J3C

-  Cric pneumatico portatile a 3 stadi con carrello
-  **Pneumatic 3-stage jack with trolley**
-  Pneumatischer Wagenheber mit 3 Stufen, mit Wagen
-  Cric pneumatique à 3 étages à chariot
-  Gato neumático portátil de 3 etapas con carrito





 Guida telescopica interna • Valvola di sicurezza • Dispositivo di arresto a fine corsa

 **Telescopic stabiliser • Safety valve • Stroke limiting device**

 Innere teleskopische Führung • Sicherheitsventil • Automatische Arretierung bei Maximalhöhe

 Guidage télescopique interne • Soupape de surpression • Dispositif d'arrêt à la hauteur maximale

 Guía telescópica interna • Válvula de seguridad • Dispositivo de paro en final de carrera

 Dati tecnici	 Technical data	 Technische Eigenschaften	 Caractéristiques techniques	 Datos técnicos	J2P J2C	J3P J3C	
Portata	Capacity	Tragfähigkeit	Capacité	Capacidad de carga	t	2	2
Pressione lavoro	Working pressure	Hubdruck	Pression de travail	Presión de trabajo	bar	7	7
Corsa	Stroke	Hubhöhe	Course	Carrera	mm	165	190
Peso	Weight	Gewicht	Poids	Peso	Kg	14	16

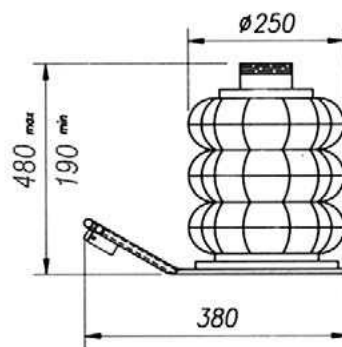
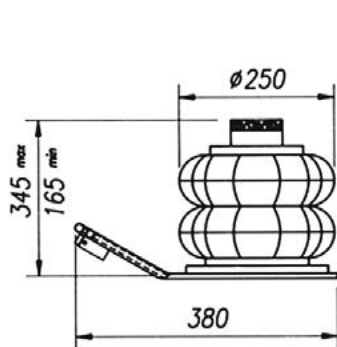

 Opzioni	 Optionals	 Sonderzubehör	 Options	 Opcionales
Prolunga 50mm Extension 50mm Verlängerung 50mm Rallonge 50mm Prolongación 50mm			Prolunga 100 mm Extension 100 mm Verlängerung 100 mm Rallonge 100 mm Prolongación 100mm	