





SATURNUS EV50 5,0 t







-  Sollevatore elettroidraulico a forbice
-  Electrohydraulic scissor car lift
-  Elektrohydraulische Scherenhebebühne
-  Pont élévateur électro-hydraulique à double ciseaux
-  Rampa tipo tijera electro-hidraulico para autos



Su versioni 'LT' e 'ATLT': Sollevatore ausiliario da 4,0 t
On 'LT' and 'ATLT' versions: Lifting table with 4,0 t capacity
Für Ausführungen 'LT' und 'ATLT': Radfreiheber 4,0 t Tragkraft
Sur versions 'LT' et 'ATLT': Levage auxiliaire capacité 4,0 t
En versiones 'LT' y 'ATLT': elevador auxiliar de 4,0 t



-  Sincronismo idraulico delle pedane • Sicurezza idraulica composta da 2 circuiti volumetrici • Sicurezza idraulica in caso di sovraccarico • Sicurezza idraulica in caso di rottura dei tubi • Pompa manuale in caso di assenza di energia elettrica • Comandi uomo presente, 24V • Doppio cilindro nelle torrette (LT e ATLT) • Serie 4 tamponi in gomma (LT e ATLT) • Incavi anteriori e piastre oscillanti posteriori per assetto ruote sui modelli AT e ATLT • Guide laterali per traverse idrauliche • Segnale acustico ultimo tratto di discesa • Sicurezza meccanica fra i cilindri per un perfetto livellamento delle piattaforme (versioni AT ATLT) - OPZIONE 1: Kit da incasso - OPZIONE 2: kit per sopra pavimento
-  Hydraulic platforms' synchronization • 2 independent hydraulic circuits • Overload safety valve • Safety valve in the event of sudden loss of pressure • Manual descent system in the event of power failures • 24V "dead man" controls • auxiliary lifting tables with double cylinders' system and 4 rubber pads (LT and ATLT versions) • Set of 4 rubber pads (LT and ATLT) • Front recesses and rear slip plates for wheel alignment (AT and ATLT versions) • Lateral rails for jack ing beams • Acoustic warning in the last portion of descent • Mechanical locks between the cylinders for a perfect levelling of the platforms (AT and ATLT versions) - OPTION 1: recessed installation kit - OPTION 2: on floor installation kit
-  Hydraulische Gleichlaufregulierung der Fahrschienen • Hydraulische Sicherheitseinrichtung besteht aus 2 volumetrischen Schaltungen • Überlastsicherung mittels Überdruckventil • Rohrbruchsicherung • Handpumpe zum manuellen Absenken bei Stromausfall • Totmann-Steuerung (24 V-Niederspannung) • Radfreiheber mit Doppelzylinder (LT und ATLT) • Fahrzeugaufnahme-Gummiblöcke 4 stk. (LT und ATLT) • Vordere Aussparungen und hintere Schiebepplatten für Achsvermessung auf • Mechanische Klinken zwischen den Zylindern für eine perfekte Nivellierung der Plattformen (AT und ATLT Versionen) - Version 1: Bodenebeneneinbau Satz - Version 2: Auf Boden
-  Synchronisation hydraulique des plateformes • Dispositif de sécurité hydraulique composé de 2 circuits volumétriques • Sécurité hydraulique en cas de surcharge • Sécurité hydraulique en cas de rupture de tuyauterie • Pompe manuelle de descente en cas de coupure de courant • Commandes de type "homme mort" à 24V • Levage auxiliaire avec double vérin (LT et ATLT) • Jeux de 4 tampons en caoutchouc (LT et ATLT) • Encastremets avant et plateaux de réalignement arrière pour géométrie sur les modèles AT et ATLT • Rails latéraux pour traverse hydraulique • Signal sonore sur la dernière partie de descente • Sécurités mécaniques entre les cylindres pour une parfaite mise à niveau des plates-formes (versions ATLT et AT) - OPTION 1: kit pour encastrement - OPTION 2: kit pour montage sur le sol
-  Sincronización hidráulica de las plataformas • Dispositivo de seguridad hidráulico consta de 2 circuitos volumétricas • Seguridad hidráulica contra sobrecarga • Seguridad hidráulica en caso de rotura tubos • Bomba manual para el caso de corte de la corriente • Mandos de hombre presente, 24V • Torretas con doble cilindro (LT y ATLT) • Juego de 4 tacos en goma (LT y ATLT) • Asientos delanteros y platos oscilantes traseros para alineación de las ruedas en modelos AT y ATLT • Guías laterales para travesaños hidráulicos • Señal acústica último tramo de descenso • Cerraduras mecánicas entre los cilindros para una perfecta nivelación de las plataformas (AT y versiones ATLT) - OPCION 1: kit para empotrar - OPCION 2: kit para instalacion al suelo

SATURNUS EV50 5,0 t

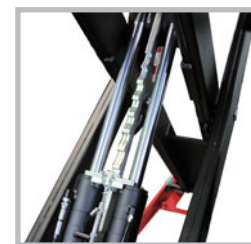
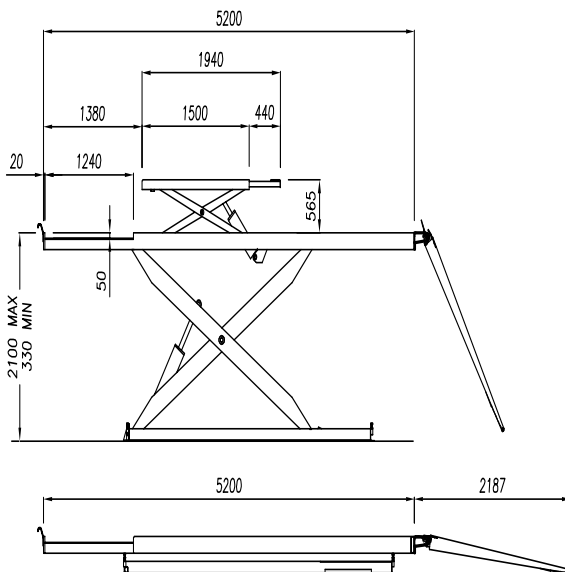
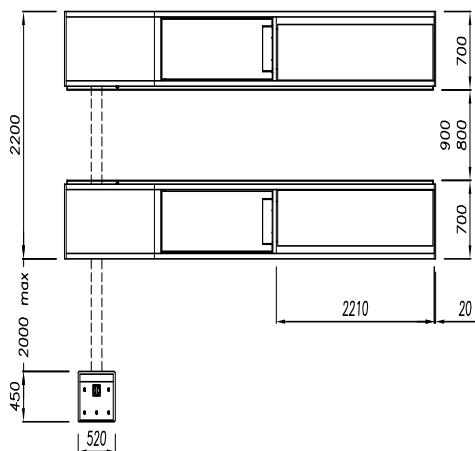

Sicurezza meccanica
Mechanical locking system
AT-ATLT



Quadro comando
Control panel

Rev.1 25-3-14

Dati tecnici	Technical data	Technische Eigenschaften	Caractéristique techniques	Datos técnicos	
Funzionamento Elettroidraulico	Operation Electro-hydraulic	Funktionsweise Elektrohydraulisch	Fonctionnement • Électrohydraulique	Funcionamiento Electro-hidráulico	
Portata	Capacity	Tragfähigkeit	Capacité	Capacidad	5000 kg
Peso	Weight	Gewicht	Poids	Peso	1500-2300 kg
Salita/Discesa	Lifting/lowering	Hub/Senkzeit	Levage/descente	Subida/bajada	40 s - 30 s Optional INVERTER 22s - 30 s
Altezza di sollevamento	Lifting height	Hubhöhe	Hauteur de levage	Altura de elevación	2100 mm + (565 mm**)
Altezza minima*	Min. height*	Mindesthöhe*	Hauteur min.*	Altura mínima*	330 mm
Motore	Motor	Motorleistung	Puissance moteur	Motor	4 kW - 230-400 V/50 Hz 3 ph
Alimentazione pneumatica	Pneumatic feed	Betriebsdruck •	Alimentation pneumatique	Alimentación neumática	6 - 8 bar

Opzioni	Optionals	Sonderzubehör	Options	Opcionales
---------	-----------	---------------	---------	------------



.7

Traversa idraulica
Jacking beam
Zusatz-Radfreiheber
Traverse de levage
Travesaño hidráulico



Prolunghe per tubi idraulici (1 m / 2 m)
Hose extensions (1 m / 2 m)
Schlauchverlängerungen (1 m / 2 m)
Rallonges pour tuyaux hydrauliques (1m / 2m)
Prolongaciones para tubos hidráulicos (1 m / 2 m)



Serie rampe salita/discesa (2)
Drive-on / Drive-off ramps (2)
Auf- und Abfahrampen (2)
Rampes de montée / descente (2)
Juego de rampas de acceso (2 unidades)



Provagiocchi
Play detector
Gelenkspieltester
Plaques à jeux
Detector de holguras

Dispositivo ricerca 2 posizioni di stazionamento
Electronic device for 2 parking position
Elektronische 2-Parkpositionen Vorrichtung
Dispositif de recherche des deux position de stationnement
Aparato de búsqueda de 2 posiciones de aparcamiento

Kit illuminazione
Illumination kit
Beleuchtungsset
Kit d'éclairag
Kit de la iluminación

Rampe ausiliarie per vetture ribassate
Auxiliary ramps for lowered cars
Zusatzzrampen für tiefgelegte Fahrzeug
Rampes auxiliaires pour voitures surbaissée
Rampas auxiliares para vehiculos de perfil baj

Traverse per veicoli speciali
Crosspieces for special vehicles
Traversen für Sonderfahrzeuge
Traverses pour véhicules spéciaux
Travesaños para los vehiculos especiales

INVERTER
INVERTER
INVERTER
INVERTER