











STRATOS SRE/S | 3,5 t



-  Sollevatore idraulico a forbice a profilo super-ribassato.
-  **Extra-low-profile hydraulic scissor lift.**
-  Elektrohydraulische Scherenhebebühne mit extra-niedriger Überfahrhöhe.
-  Pont à ciseaux super-surbaissé.
-  Elevador hidráulico de tijera de perfil súper-bajo.



-  Rampette di salita e discesa di facile movimentazione • Sincronismo idraulico delle pedane • Sicurezza idraulica in caso di sovraccarico • Sicurezza idraulica in caso di rottura dei tubi • Valvola controllo velocità di discesa • Comandi uomo presente, 24V • Serie 4 tamponi in gomma • Segnale acustico ultimo tratto di discesa
-  **Easy to handle drive-on and drive-off ramps • Hydraulic synchronization of platforms • Overload safety-valve • Safetyvalve in case of sudden loss of pressure • Descentspeed control valve • "Dead man" controls 24V • Set of 4 rubber pads • 'Buzzer' on last portion of descent**
-  Einfachste Bedienung der Auf- und Abfahrrampen • Hydraulische Gleichlaufregulierung der Fahrschienen • Überlastsicherung mittels Überdruckventil • Rohrbruchsicherung • Sinkgeschwindigkeitsregelventil • Totmann-Steuerung (24 V-Niederspannung) • 4 Fahrzeugaufnahme-Gummiblöcke • Akustisches Signal im letzten Teil der Senkbewegung
-  Rampes de montée et descente • Synchronisation hydraulique des plateformes • Sécurité hydraulique en cas de surcharge • Sécurité hydraulique en cas de rupture de tuyauterie • Soupape de contrôle de vitesse de descente • Commandes de type "homme mort" à 24V • Jeux de 4 taquets en caoutchouc • Signal sonore sur la dernière partie de descente
-  Rampas de subida y bajada fáciles de desplazar • Sincronización hidráulica de las plataformas • Seguridad hidráulica contra sobrecarga • Seguridad hidráulica en caso de rotura tubos • Seguridad mecánica de cremallera • Válvula de control de velocidad • Mandos de hombre presente, 24V • Juego de 4 tacos en goma • Señal acústica último tramo de descenso

STRATOS SRE/S | 3,5 t

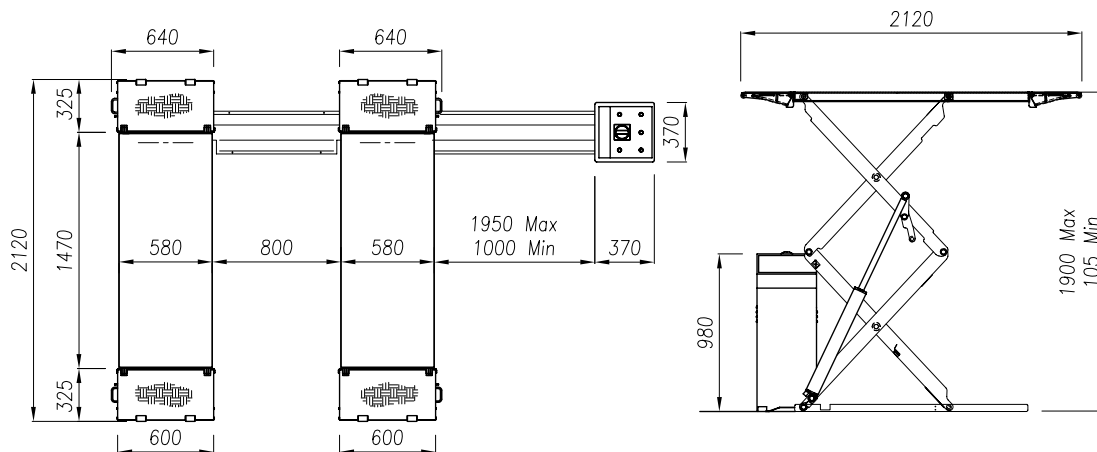

Dati tecnici	Technical data	Technische Eigenschaften	Caractéristiques techniques	Datos técnicos	
Portata	Capacity	Tragfähigkeit	Capacité	Capacidad	3.500 kg
Peso	Weight	Gewicht	Poids	Peso	750 kg
Salita/Discesa	Lifting/lowering	Hub/Senkzeit	Levage/déscente	Subida/Baja	35/40 s
Altezza di sollevamento	Lifting height	Hubhöhe	Hauteur de levage	Altura de elevación	1900 mm
Motore	Motor	Motorleistung	Puissance moteur	Motor	2,2 kW -230-400V/50Hz-3ph



Installazione standard sopra pavimento • Altezza minima: 98 mm • Facile accesso anche con vetture ribassate

Surface mounted version as a standard • Minimal height: 98 mm • Easy to drive-over even with low cars

Aufbodenversion ist Standard • Mindesthöhe: 98 mm • Einfaches Überfahren auch mit tiefgelegten Fahrzeugen

Version installée sur sol est standard • Hauteur minimum: 98 mm • Accès très facile même avec voitures très basses

Instalación estándar sobre suelo • Altura mínima: 98 mm • Fácil acceso también con vehículos de perfil bajo



• Doppio circuito idraulico di sicurezza • Coppia di cilindri volumetrici sotto ciascuna pedana

• Double hydraulic system • Double volumetric cylinder under each platform

• Zweifaches Hydrauliksystem • Doppelzylinder in jeder Schere • Système hydraulique double • Double vérin hydraulique sous chaque plateforme

• Doble circuito hidráulico de seguridad • Pareja de cilindros volumétricos debajo de cada plataforma



Opzioni	Optionals	Sonderzubehör	Options	Opcionales
Prolunghe per tubi idraulici 2 m	Hose extensions 2 m	Schlauchverlängerungen 2 m	Rallonges pour tuyaux hydrauliques 2 m	Traverses pour véhicules spéciaux ongaciones para tubos hidráulicos 2 m
Esecuzione monofase	Single phase version	Einphasige Ausführung	Version monophasée	Motor monofásico
Telaio per incasso	Recess frame	Bodeneinbaurahmen	Cadre de montage en encastrement	Estructura para empotrar
Kit scivoli per incasso	Kit of embedded run-on and run-off skids	Satz Abrollrampen für Bodeneinbad	Jeu de rampes de roulement pour encastrement	Juego de rampas para empotrar
Rampe ausiliarie per vetture super ribassate	Auxiliary ramps for super lowered cars	Zusatzzrampen für tiefgelegte super Fahrzeuge	Rampes auxiliaires pour voitures super surbaissées	Rampas auxiliares para vehículos de perfil super bajo
Traverse per veicoli speciali	Crosspieces for special vehicles	Traversen für Sonderfahrzeuge		Travesaños para vehículos especiales