











# STRATOS SRM 3,2 t | SRE 3,5 t



-  Sollevatore idraulico a forbice a profilo super-ribassato
-  Extra-low-profile hydraulic scissor lift
-  Elektrohydraulische Scherenhebebühne mit extra-niedriger Überfahrhöhe
-  Pont à ciseaux super-surbaissé
-  Elevador hidráulico de tijera de perfil súper-bajo



-  Rampette di salita e discesa di facile movimentazione • Sincronismo idraulico delle pedane • Sicurezza idraulica in caso di sovraccarico • Sicurezza idraulica in caso di rottura dei tubi • Regolazione automatica della discesa • Comandi uomo presente, 24V • Serie 4 tamponi in gomma • Segnale acustico ultimo tratto di discesa
-  Easy to handle drive-on and drive-off ramps • Hydraulic synchronization of platforms • Overload safety-valve • Safety-valve in case of sudden loss of pressure • Automatic lowering control • "Dead man" controls 24V • Set of 4 rubber pads • 'Buzzer' on last portion of descent
-  Einfachste Bedienung der Auf- und Abfahrampen • Hydraulische Gleichlaufregulierung der Fahrschienen • Überlastsicherung mittels Überdruckventil • Rohrbruchsicherung • Automatische Senkregulierung • Totmann-Steuerung (24 V-Niederspannung) • 4 Fahrzeugaufnahme-Gummiblöcke • Akustisches Signal im letzten Teil der Senkbewegung
-  Rampes de montée et descente • Synchronisation hydraulique des plateformes • Sécurité hydraulique en cas de surcharge • Sécurité hydraulique en cas de rupture de tuyauterie • Autorégulation de descente • Commandes de type "homme mort" à 24V • Jeux de 4 taquets en caoutchouc • Signal sonore sur la dernière partie de descente
-  Rampas de subida y bajada fáciles de desplazar • Sincronización hidráulica de las plataformas • Seguridad hidráulica contra sobrecarga • Seguridad hidráulica en caso de rotura tubos • Seguridad mecánica de cremallera • Regulación automática del descenso • Mandos de hombre presente, 24V • Juego de 4 tacos en goma • Señal acústica último tramo de descenso

# STRATOS SRM 3,2 t

# SRE 3,5 t

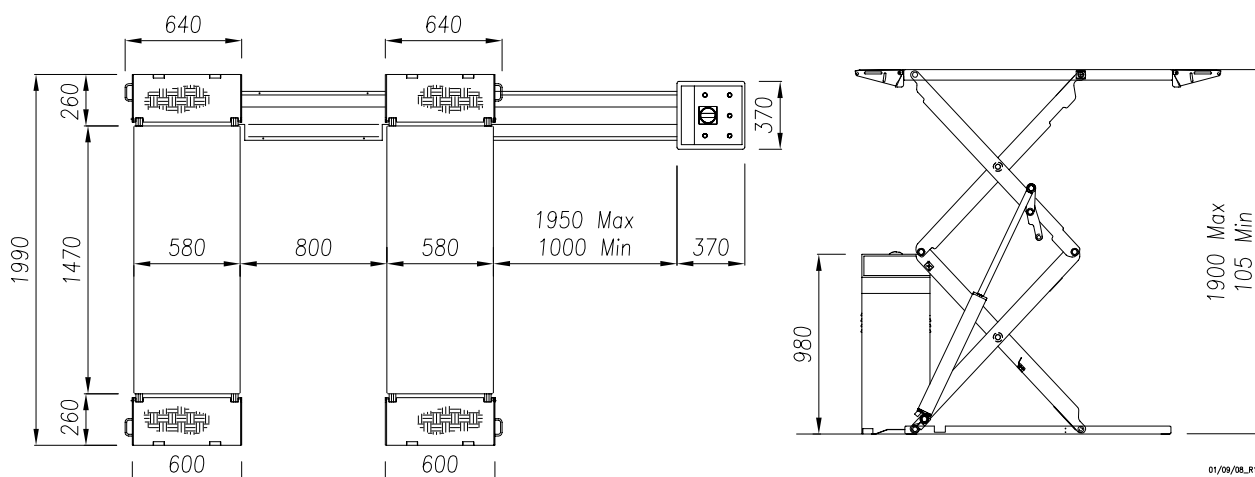

01/09/08\_R1



## Dati tecnici

## Technical data

## Technische Eigenschaften

## Caractéristiques techniques

## Datos técnicos

	SRM	SRE
Funzionamento • Operation • Funktionsweise • Fonctionnement • Funcionamiento	Elettroidraulico • Electro-hydraulic • Elektrohydraulisch • Electrohydraulique • Electro-hidráulico	Elettroidraulico • Electro-hydraulic • Elektrohydraulisch • Electrohydraulique • Electro-hidráulico
Portata • Capacity • Tragfähigkeit • Capacité • Capacidad	3.200 kg	3.500 kg
Peso • Weight • Gewicht • Poids • Peso	730 kg	750 kg
Salita/Discesa • Lifting/lowering • Hub/Senkzeit • Levage/descente • Subida/bajada		35/40 s
Altezza di sollev. • Lifting height • Hubhöhe • Hauteur de levage • Altura de elevación		1900 mm
Motore • Motor • Motorleistung • Puissance moteur • Motor		2,2 kW - 230-400 V/50 Hz 3 ph

Installazione standard sopra pavimento • Altezza minima: 98 mm • Facile accesso anche con vetture ribassate

Surface mounted version as a standard • Minimal height: 98 mm • Easy to drive-over even with low cars

Aufbodenversion ist Standard • Mindesthöhe: 98 mm • Einfaches Überfahren auch mit tiefgelegten Fahrzeugen

Version installée sur sol est standard • Hauteur minimum: 98 mm • Accès très facile même avec voitures très basses

Instalación estándar sobre suelo • Altura mínima: 98 mm • Fácil acceso también con vehículos de perfil bajo

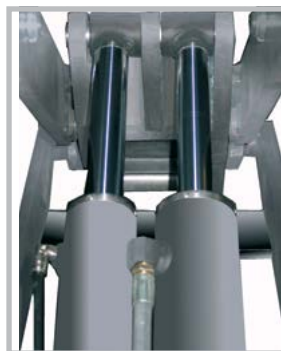

Doppio circuito idraulico di sicurezza • Coppia di cilindri volumetrici sotto ciascuna pedana

**Double hydraulic system • Double volumetric cylinder under each platform**

Zweifaches Hydrauliksystem • Doppelzylinder in jeder Schere

Système hydraulique double • Double vérin hydraulique sous chaque plateforme

Doble circuito hidráulico de seguridad • Pareja de cilindros volumétricos debajo de cada plataforma



## Opzioni

## Optionals

## Sonderzubehör

## Options

## Opcionales

Prolunghe per tubi idraulici 2 m	Hose extensions 2 m	Schlauchverlängerungen 2 m	Rallonges pour tuyaux hydrauliques 2 m	Traverses pour véhicules spéciaux ongaciones para tubos hidráulicos 2 m
Esecuzione monofase	Single phase version	Einphasige Ausführung	Version monophasée	Motor monofásico
Telaio per incasso	Recess frame	Bodeneinbaurahmen	Cadre de montage en encastrement	Estructura para empotrar
Kit scivoli per incasso	Kit of embedded run-on and run-off skids	Satz Abrollrampen für Bodeneinbad	Jeu de rampes de roulement pour encastrement	Juego de rampas para empotrar
Rampe ausiliarie per vetture super ribassate	Auxiliary ramps for super lowered cars	Zusatzrampen für tiefgelegte super Fahrzeuge	Rampes auxiliaires pour voitures super surbaissées	Rampas auxiliares para vehículos de perfil super bajo
Traverse per veicoli speciali	Crosspieces for special vehicles	Traversen für Sonderfahrzeuge		Travesaños para vehículos especiales