











# TITANIUM 1000



-  Smontagomme elettroidraulico per rapido smontaggio e montaggio pneumatici con e senza camera d'aria di autocarri, autobus e veicoli industriali, con cerchi a canale e ad anello elastico.
-  **Easy demounting and mounting electro-hydraulic tyre changer for trucks, buses and industrial vehicles tubed or tubeless, with groove rim and split ring rim.**
-  Elektrohydraulische Reifenmontiermaschine für schlauchlose und Schlauchreifen für Lkw, Busse und Nutzfahrzeuge, mit Tiefbett- oder Sprengringfelgen.
-  Démonte-pneus électro-hydraulique pour camion pour le montage et le démontage de roues de camions, bus et véhicules industriels avec ou sans chambre à air, avec jante à rainure ou à bague fendue.
-  Desmontadora electrohidráulica para desmontaje y montaje rapido de neumáticos de camiones, autobuses y vehiculos industriales, con y sin cámara de aire, para llantas canal o llantas con anillo elástico.



-  • Mandrino autocentrante a due velocità di rotazione (5 - 10 giri/minuto). • Per pneumatici tube e tubeless da 13" a 27".
-  • Double speed self-centring chuck (5 - 10 rpm). • For tube and tubeless-type tyres from 13" to 27" diameters.
-  • Selbstzentrierendes Universal-Spannfutter mit zwei Drehgeschwindigkeiten (5 - 10 UpM). • Für Reifen mit oder ohne Schlauch von 13" bis 27" Durchmesser.
-  • Mandrin universel à deux vitesses (5 - 10 tours/min.). • Pour pneus avec chambre air et tubeless de 13" à 27" de diamètre.
-  • Autocentrante con dos velocidades (5 - 10 rpm). • Para neumáticos tube y tubeless entre 13" y 27".

# TITANIUM 1000

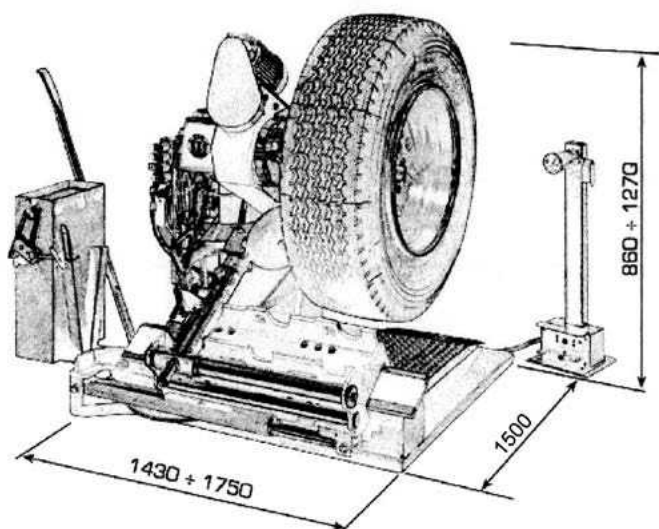

- Carrello con movimento idraulico e braccio utensili con traslazione manuale
- Hydraulically operated carriage, tool holder arm with manual traverse
- Schlitten mit hydraulischem Antrieb und Montagewerkzeug mit manueller Verfahrensteuerung
- Chariot à mouvement hydraulique et bras porte-outils à translation manuelle
- Carro con movimiento hidráulico y brazo para herramientas con traducción manual



- Unità di controllo portatile
- Portable control unit
- Mobile Steuereinheit
- Unité de commande mobile
- Unidad de control portátil

Dati tecnici	Technical data	Technische Eigenschaften	Caractéristiques techniques	Datos técnicos	
Diametro cerchio	Rim diameter	Felgendurchmesser	Diamètre de la jante	Diámetro llanta	13" - 27"
Diametro massimo ruota	Max.wheel diameter	Max.Reifendurchmesser	Diamètre max. du pneu	Diámetro máximo rueda	1.600 mm (63")
Larghezza massima ruota	Max.wheel width	Max.Reifenbreite	Largeur max. du pneu	Anchura máxima rueda	780 mm (31")
Peso massimo ruota	Max. wheel weight	Max. Radgewicht	Poids max. de la rue	Peso máximo rueda	1.270 Kg
Motore centralina idraulica	Motor of hydraulic pump	Motor der Hydraulikpumpe	Moteur de la pompe hydraulique	Motor centralita hidráulica	1,1 kW
Motore riduttore	Gear motor	Motorleistung des Getriebes	Moteur du réducteur	Motor reductor	1,3/1,8 kW
Tensione di alimentazione trifase	Feeding tension (3-phase)	Drehstrom-Versorgungsspannung	Tension de alimentation triphasée	Tensión de alimentación trifásica	400V 50 Hz - 3 ph
Forza di stallatura	Bead breaking force	Abdrückkraft	Force du détalonneur	Fuerza de destalonado	14700 N (1.500 Kg)
Pressione di esercizio	Operating pressure	Betriebsdruck	Pression de travail	Presión de servicio	0-130 bar

\* Optional 230 V 50 Hz - 3 ph