











W106 | 2000 kg



-  Gru idrauliche serie pesante, doppio effetto
-  **Heavy duty hydraulic cranes, double acting**
-  Hydraulische Kräne, doppeltwirkend, schwere Serie
-  Grues hydrauliques série renforcée, double effet
-  Grúas hidráulicas serie pesada, doble acción



-  Pompa a doppio effetto • Valvola limitatrice di carico • Comando tipo uomo presente • Stelo cromato
-  **Double acting pump • Overload safety-valve • Dead man controls • Chromium plated rod**
-  Doppeltwirkende Pumpe • Überlastsicherung • Totmann-Senkventil • Verchromte Kolbenstange
-  Pompe double effet • Sécurité hydraulique en cas de surcharge • Commande de type "homme mort" • Tige chromée
-  Bomba de doble acción • Válvula limitadora de carga • Mando de tipo hombre presente • Vástago cromado

W106 | 2000 kg

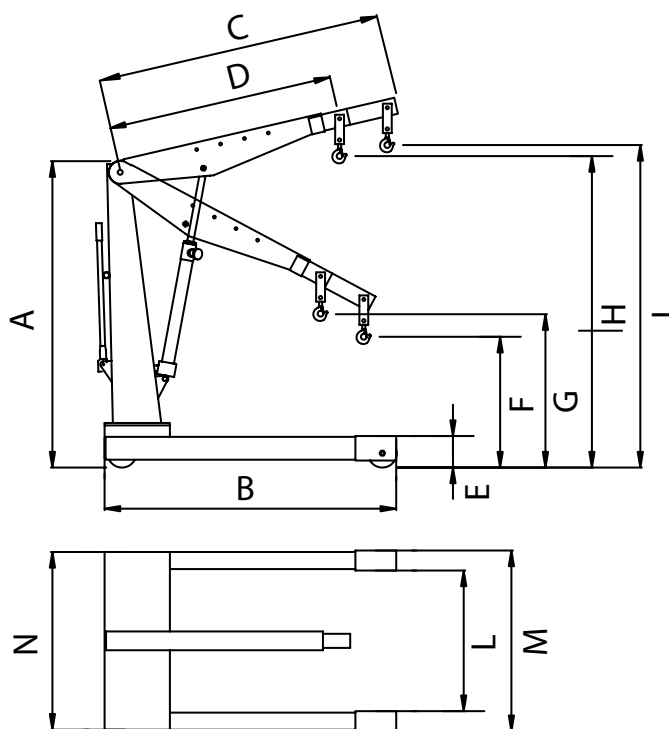

Dati tecnici



Technical data



Technische Eigenschaften



Caractéristiques techniques



Datos técnicos

	W106
A	2000
B	1970
C	1950
D	1500
E	220
F	530
G	810
H	2930
I	3280
L	1150
M	1350
N	1340
kg	300

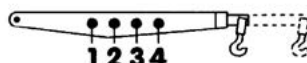

Kg

1	2000
2	1500
3	1000
4	600