











-  Cricchi ad alta portata
-  High capacity jacks
-  Rangierheber mit hoher Tragkraft
-  Crics haute capacité
-  Gatos de alta capacidad de carga



-  Manico ergonomico per il comfort dell'utilizzatore. Ricoperto in gomma • Il sistema di discesa "solleva e gira" previene abbassamenti non intenzionali • Valvola di controllo abbassamento per una discesa sicura perfino con il massimo carico • Il pedale a piede addizionale permette un sollevamento veloce della sella • Ruote a diametro largo per movimentazione facile.
-  Ergonomically designed handle for operator comfort. Rubber coated • "Lift-and-turn" lowering system prevents unintentional lowering • Safety lowering control valve for safe lowering even under maximum load • Additional foot pedal pumping feature provides fast saddle raising to the load • Large diameter swivel wheels for easy handling.
-  Ergonomisch geformte gummiüberzogene Griffe für besseren Bedienkomfort • Heben und Drehen, Absenksystem schützt gegen unbeabsichtigtes Absacken von Lasten • Ein Sicherheitsventil zur Steuerung des Absenkvorganges gewährleistet das Ablassen von Lasten mit definierter Geschwindigkeit und schützt gegen unbeabsichtigtes Absacken von Lasten auch unter max. Traglast • Zusätzliches Fußpedal zum schnellen Hochfahren des Sattels (Schnellhub) • Grosse Schwenkrollen für Stabilität und Wendigkeit unter Last.
-  Poignée de conception ergonomique pour un grand confort d'utilisation. Revêtement de caoutchouc • "Dispositif de descente "levage et blocage" empêchant toute descente intempestive • La pédale additionnelle de pompage assure unlevage rapide du sabot d'appui vers la charge • Vanne-pilote de sécurité pour une descente sûre, même sous la charge maximale • Roues pivotantes de grand diamètre pour manutention facile.
-  Mango ergonómico para el confort del usuario. Revestido en goma • El sistema de descenso "eleva y gira" impide bajadas no intencionadas • Válvula de control de bajada para un descenso seguro también con la carga máxima • El pedal adicional permite una elevación rápida de la silla • Ruedas de diámetro grande para un desplazamiento facilitado.



Dati tecnici

Technical data

Technische Eigenschaften

Caractéristiques techniques

Datos técnicos

MOD.	Max (Ton)	A (mm)	B (mm)	C (mm)	D (mm)	E (mm)	F (mm)	Kg
WJK-6T/CK	6	145	560	1270	200	465	1045	70
WJK-10T/CK	10	155	570	1395	210	470	1045	90
WJK-12T/CK	12	170	690	1700	280	470	1045	136
WJK-20T/CK	20	200	600	1790	325	475	1480	164

Altezza min. 145 mm
Min. height 145 mm.
 Min. Hubhöhe 145 mm.
 Hauteur minimale 145 mm.
 Altura mín. 145 mm

Altezza minima del telaio 200 mm
Min. chassis height 200 mm
 Min. Chassishöhe 200 mm
 Hauteur minimale du châssis: 200 mm
 Altura mínima del chasis 200 mm

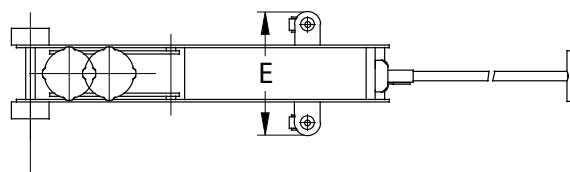

Altezza di entrata ultra bassa
Ultra low entry height
 Ultraflache Aufnahmehöhe
 Prise très basse de la charge
 Altura de entrada ultra baja

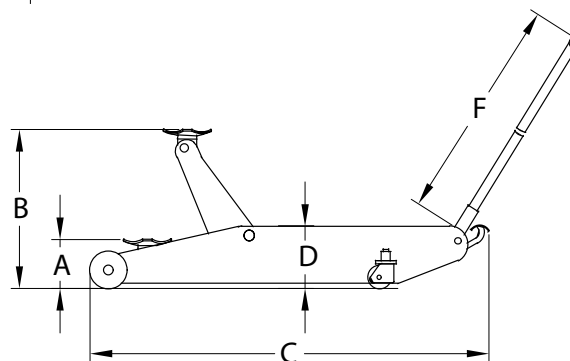

Opzioni

Optionals

Sonderzubehör

Options

Opcionales



CD0600

Le ruote ad aria in gomma fissate sul punto di equilibrio accrescono la manovrabilità dei grossi cricchi.

Air rubber tyres enhance manoeuvrability.

Zum Transport der Heber empfehlen wir Luftgummiräder.

Des pneumatiques améliorent la manoeuvrabilité.

Las ruedas neumáticas en goma, fijadas en el punto de equilibrio, aumentan la maniobrabilidad de los gatos grandes.



CD0603

WJK-10T / -12T / -20T (+ 40 mm)

Sella per altezze extra o accesso a punti di sollevamento posti sotto alle minigonne, etc.

Saddle for extra height or accessing lifting points situated behind skirts, etc.

Sattelverlängerung für extra hohe Aufnahmen oder schwer zugängliche Hebepunkte, z.B. Hinter Blenden.

Selle pour hauteurs exceptionnelles ou pour l'accès à des points de levage situés hors limites, etc.

Silla para alturas extra o acceso a puntos de elevación situados debajo de las minifaldas, etc.